

P-Channel Enhancement Mode MOSFET

Feature

- -40V/-75A
- | | |
|---------------------|--------------|
| $R_{DS(ON)} = 7.8$ | @VGS = -10V |
| $R_{DS(ON)} = 10.4$ | @VGS = -4.5V |
- 100% Avalanche Tested
- 100% DVDS
- MSL1 up to 260 Peak Reflow
- AEC-Q101 Qualified
- 175 operating temperature
- Reliable and Rugged
- Halogen Free and Green Devices Available (RoHS Compliant)

Pin Description

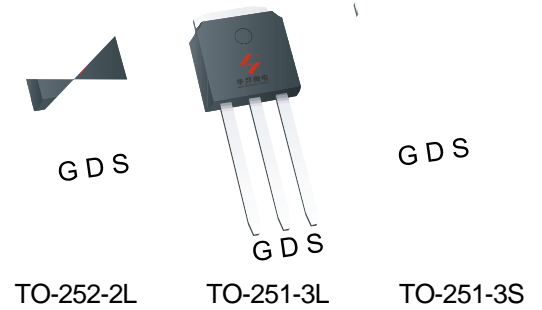

Applications

- Switching application
- Li-battery protection
- Motor control

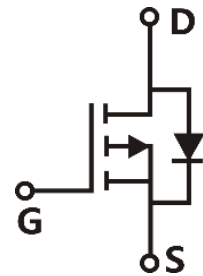

Single P-Channel MOSFET

Ordering and Marking Information

<table style="width: 100%; border: none;"> <tr> <td style="text-align: center; width: 33%;"> <div style="background-color: black; width: 15px; height: 15px; margin: 0 auto;"></div> D </td> <td style="text-align: center; width: 33%;"> <div style="background-color: black; width: 15px; height: 15px; margin: 0 auto;"></div> U </td> <td style="text-align: center; width: 33%;"> <div style="background-color: black; width: 15px; height: 15px; margin: 0 auto;"></div> V </td> </tr> <tr> <td style="text-align: center;">HYA090P04</td> <td style="text-align: center;">HYA090P04</td> <td style="text-align: center;">HYA090P04</td> </tr> <tr> <td style="text-align: center;">XYMXXXXXX</td> <td style="text-align: center;">XYMXXXXXX</td> <td style="text-align: center;">XYMXXXXXX</td> </tr> </table>	<div style="background-color: black; width: 15px; height: 15px; margin: 0 auto;"></div> D	<div style="background-color: black; width: 15px; height: 15px; margin: 0 auto;"></div> U	<div style="background-color: black; width: 15px; height: 15px; margin: 0 auto;"></div> V	HYA090P04	HYA090P04	HYA090P04	XYMXXXXXX	XYMXXXXXX	XYMXXXXXX	<p>Package Code D: TO-252-2L U: TO-251-3L V: TO-251-3S</p> <p>Date Code XYMXXXXXX</p>
<div style="background-color: black; width: 15px; height: 15px; margin: 0 auto;"></div> D	<div style="background-color: black; width: 15px; height: 15px; margin: 0 auto;"></div> U	<div style="background-color: black; width: 15px; height: 15px; margin: 0 auto;"></div> V								
HYA090P04	HYA090P04	HYA090P04								
XYMXXXXXX	XYMXXXXXX	XYMXXXXXX								

Note: HUAYI halogen free products contain molding compounds/die attach materials and 100% matte tin plate Termination finish; which are fully compliant with RoHS. HUAYI halogen free products meet or exceed the halogen free requirements of IPC/JEDEC J-STD-020 for MSL classification at halogen free peak reflow temperature. HUAYI defines Green to mean halogen free (RoHS compliant) and halogen free (Br or Cl does not exceed 900ppm by weight in homogeneous material and total of Br and Cl does not exceed 1500ppm by weight).

HUAYI reserves the right to make changes, corrections, enhancements, modifications, and improvements to this product and/or to this document at any time without notice.

Absolute Maximum Ratings

Symbol	Parameter		Rating	Unit
Common Ratings (Tc=25°C Unless Otherwise Noted)				
V _{DSS}	Drain-Source Voltage		-40	V
V _{GSS}	Gate-Source Voltage		20	V
T _J	Junction Temperature Range		-55 to 175	°C
T _{STG}	Storage Temperature Range			°C
I _S	Source Current-Continuous(Body Diode)	Tc=25°C	-75	A
Mounted on Large Heat Sink				
I _{DM}	Pulsed Drain Current *	Tc=25°C	-225	A
I _D	Continuous Drain Current	Tc=25°C	-75	A
		Tc=100°C	-53	A
P _D	Maximum Power Dissipation	Tc=25°C	108	W
		Tc=100°C	54	W
R _{θJC}	Thermal Resistance, Junction-to-Case		1.39	°C/W
R _{θJA}	Thermal Resistance, Junction-to-Ambient **		75	°C/W
E _{AS}	Single Pulsed-Avalanche Energy ***	L=0.3mH	186	mJ

Note: * Repetitive rating pulse width limited by max.junction temperature.
 ** Surface mounted on 1in2 FR-4 board.
 *** Limited by T_{Jmax}, starting T_J=25°C, L = 0.3mH, R_G= 25 Ω, V_{GS} = -10V.

Electrical Characteristics(Tc =25°C Unless Otherwise Noted)

Symbol	Parameter	Test Conditions	HYA090P04LQ1			Unit
			Min	Typ.	Max	
Static Characteristics						
BV _{DSS}	Drain-Source Breakdown Voltage	V _{GS} =0V, I _{DS} =-250 A	-40	-	-	V
I _{DSS}	Drain-to-Source Leakage Current	V _{DS} =-40V, V _{GS} =0V	-	-	-1	A
		T _J =125°C	-	-	-50	A
V _{GS(th)}	Gate Threshold Voltage	V _{DS} =V _{GS} , I _{DS} =-250 A	-1.0	-1.5	-2.0	V
I _{GSS}	Gate-Source Leakage Current	V _{GS} = 20V, V _{DS} =0V	-	-	±100	nA
R _{DS(ON)}	Drain-Source On-State Resistance	V _{GS} =-10V, I _{DS} =-20A	-	7.8	9.5	m
		V _{GS} =-4.5V, I _{DS} =-20A	-	10.4	15	m
Diode Characteristics						
V _{SD}	Diode Forward Voltage	I _{SD} =-20A, V _{GS} =0V	-	-0.86	-1.00	V
t _{rr}	Reverse Recovery Time	I _{SD} =-				

Electrical Characteristics (Cont.) (Tc =25°C Unless Otherwise Noted)

Symbol	Parameter	Test Conditions	HYA090P04LQ1			Unit
			Min	Typ.	Max	
Dynamic Characteristics						
R _G	Gate Resistance	V _{GS} =0V, V _{DS} =0V, F=500KHz	-	4.4	-	
C _{iss}	Input Capacitance	V _{GS} =0V, V _{DS} =-25V, Frequency=1MHz	-	4906	-	pF
C _{oss}	Output Capacitance					
C _{rss}	Reverse Transfer Capacitance					
t _{d(ON)}	Turn-on Delay Time	V _{DD} =-20V, R _G =2.5 I _{DS} =-20A, V _{GS} =-10V	-	9.6	-	ns
T _r	Turn-on Rise Time					
t _{d(OFF)}	Turn-off Delay Time					
T _f	Turn-off Fall Time					
Gate Charge Characteristics						
Q _g	Total Gate Charge(V _{GS} =-10V)	V _{DS} =-32V, I _{DS} =-20A	-	77	-	nC
	Total Gate Charge(V _{GS} =-4.5V)			40		
Q _{gs}	Gate-Source Charge		-	11	-	
Q _{gd}	Gate-Drain Charge		-	22	-	
V _{plateau}	Gate plateau voltage		-	-3.3	-	V

Note: *Pulse test pulse width 300us duty cycle 2%

Typical Operating Characteristics

Figure 1: Power Dissipation

Figure 2:

Typical Operating Characteristics(Cont.)

Figure 7: On-Resistance vs. Temperature

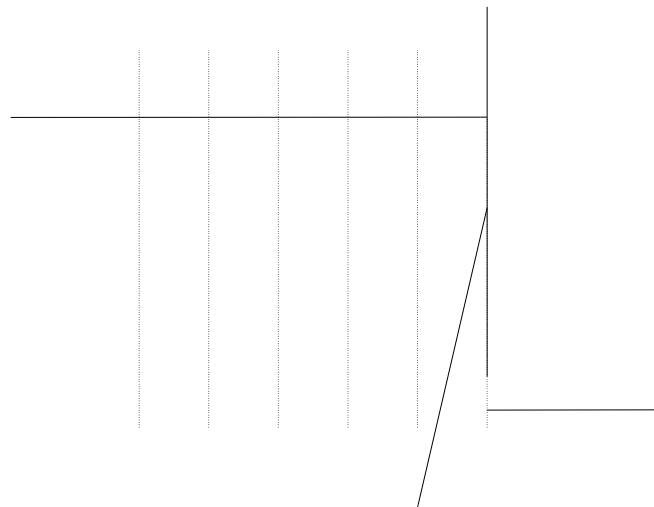

Figure 8: Source-Drain Diode Forward

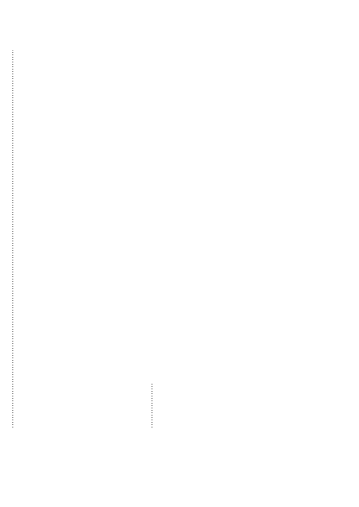

Figure 9: Capacitance Characteristics

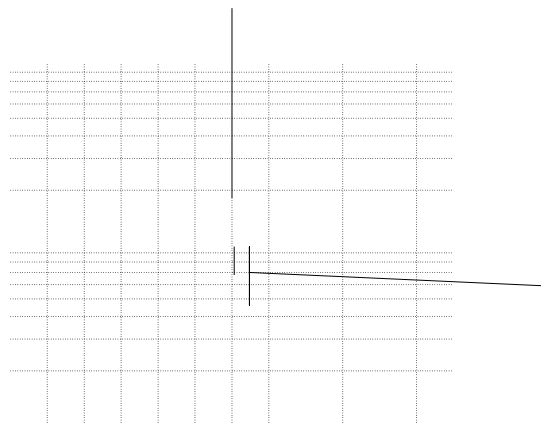

Figure 10: Gate Charge Characteristics

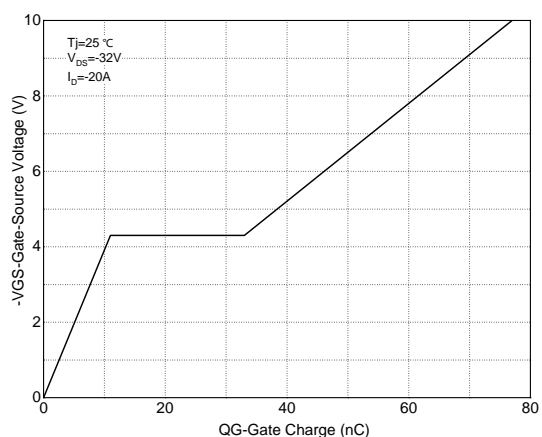

Figure 11: Transfer Characteristics

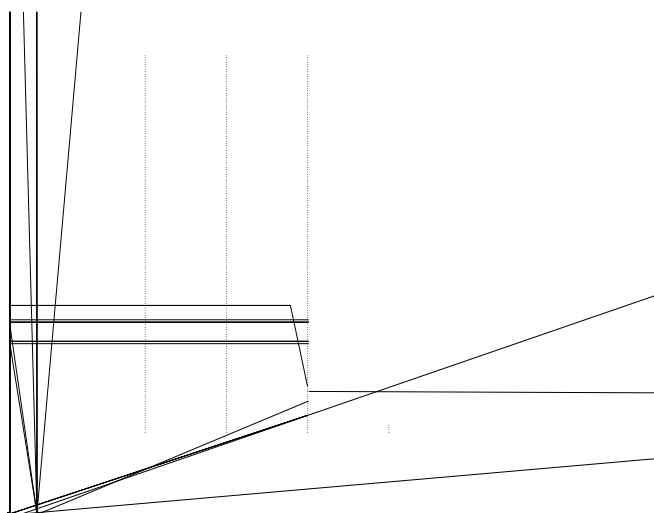
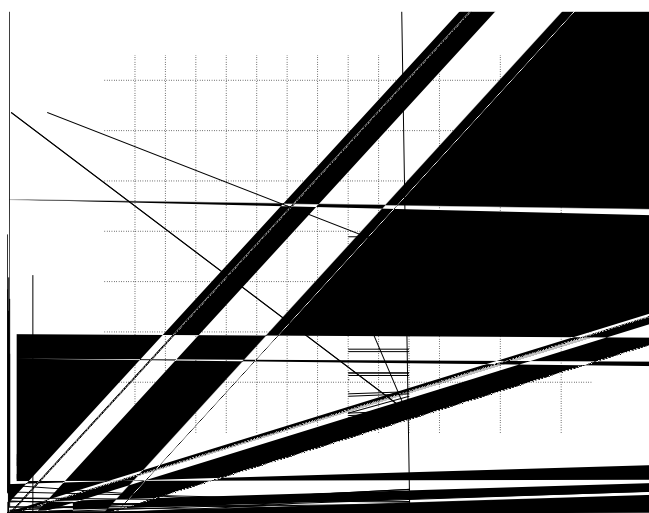

Figure 12: Gate Threshold Voltage



Typical Operating Characteristics(Cont.)

Figure 13: Drain-Source Breakdown

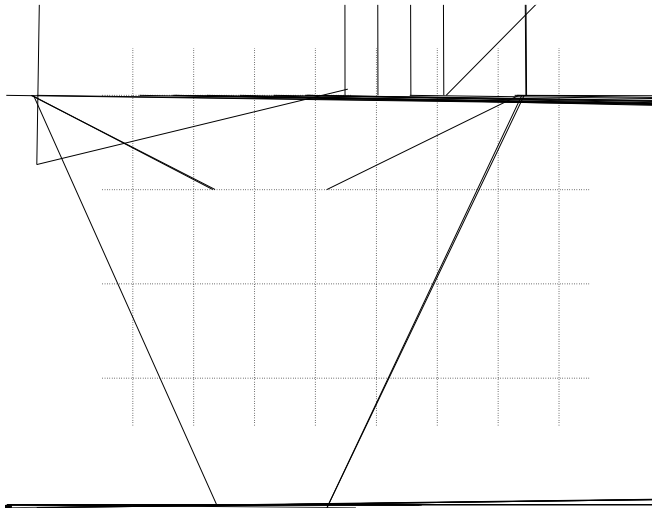

Figure 14: R_{dson} vs. Gate Voltage

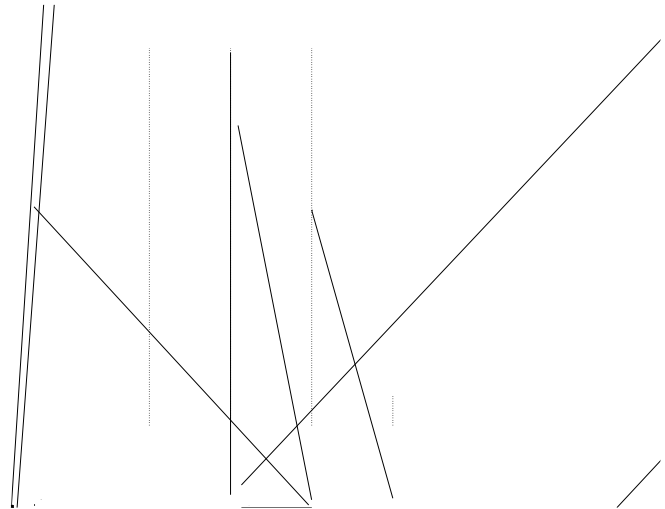
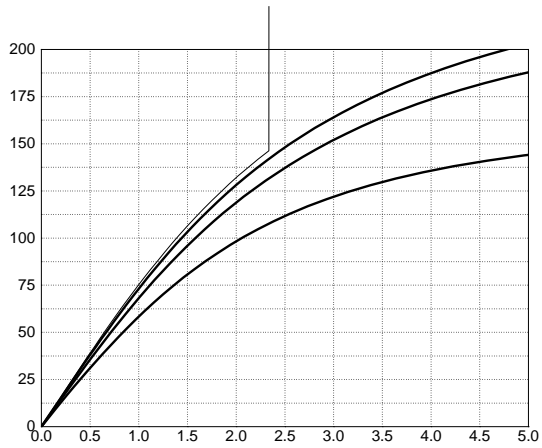
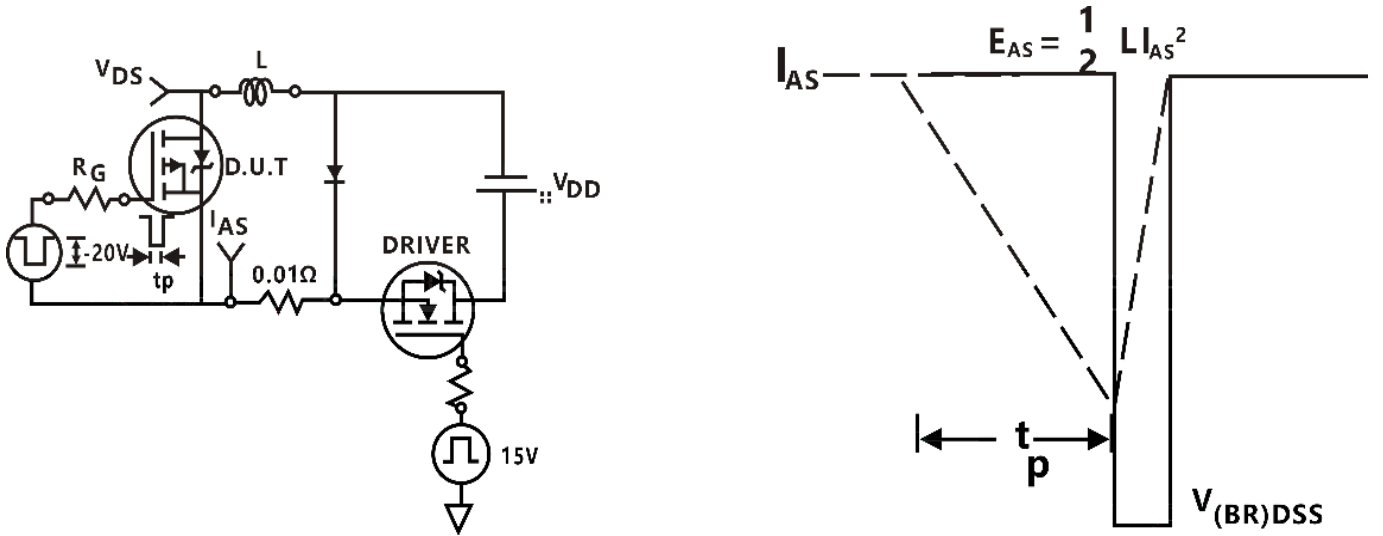

Figure 15: Output Characteristics 125



Avalanche Test Circuit



Switching Time Test Circuit

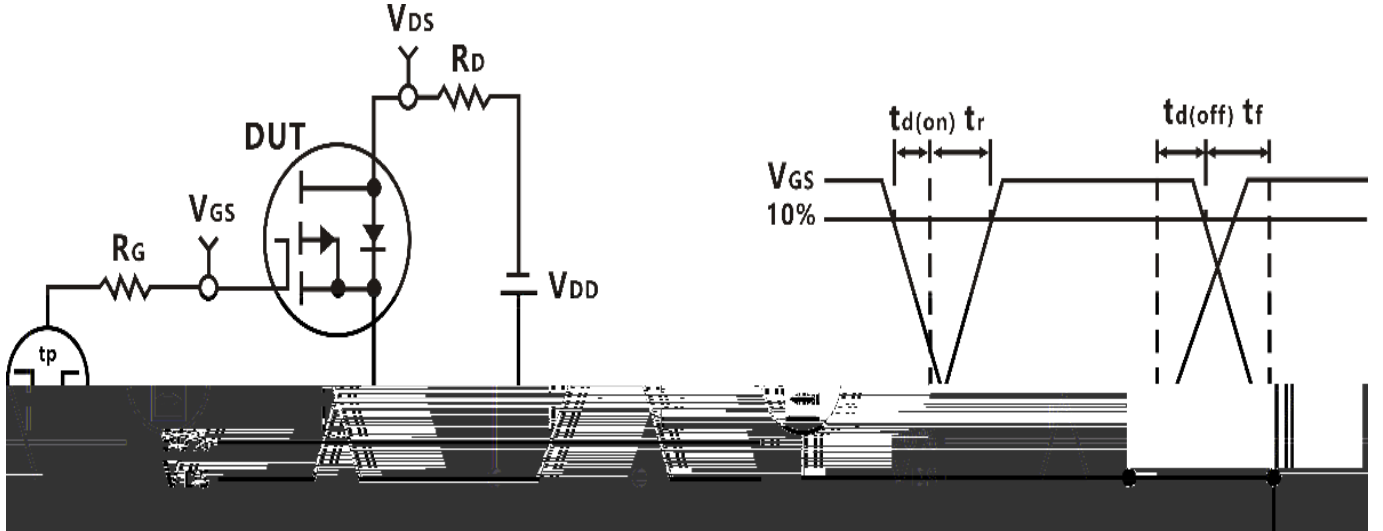

Gate Charge Test Circuit

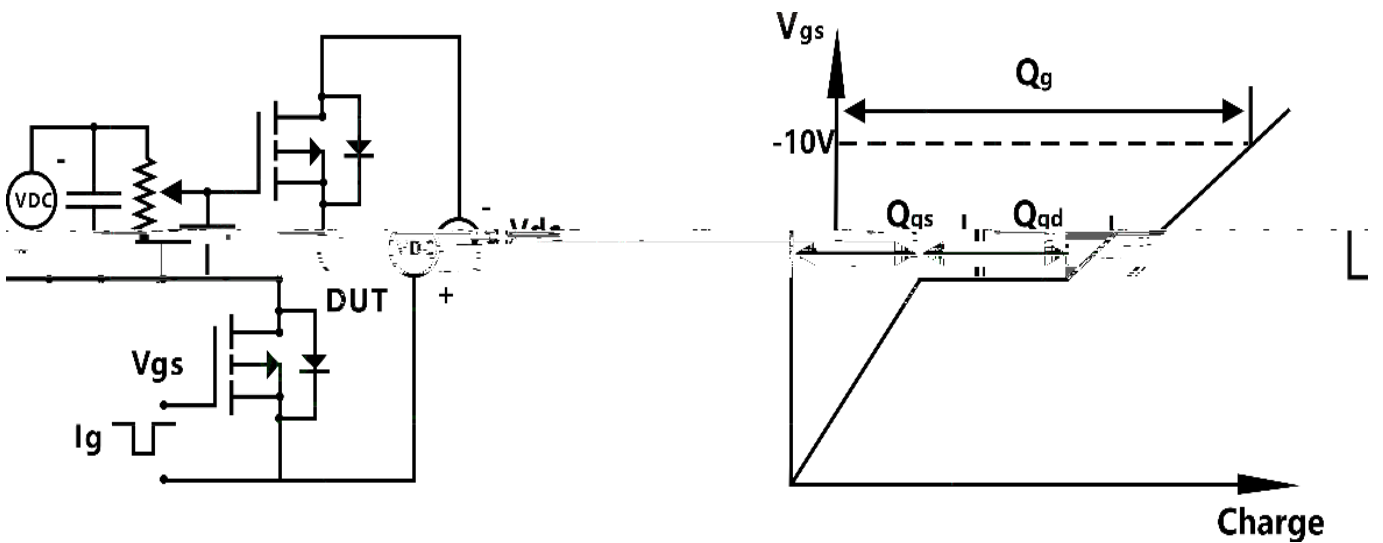

Device Per Unit

Package Type	Unit	Quantity
TO-252-2L	Tube	75
TO-252-2L	Reel	2500
TO-251-3L	Tube	75
TO-251-3S	Tube	75

Package Information

TO-252-2L

COMMON DIMENSIONS			
SYMBOL	mm		
	MIN	NOM	MAX
A	2.20	2.30	2.40
A1	0.00	-	0.20
A2	0.97	1.07	1.17
b	0.68	0.78	0.90
b3	5.20	5.33	5.50
c	0.43	0.53	0.63
D	5.98	6.10	6.22
D1	5.30REF		
E	6.40	6.60	6.80
E1	4.63	-	-
e	2.286BSC		
H	9.40	10.10	10.50
L	1.38	1.50	1.75
L1	2.90REF		
L2	0.51BSC		

TO-251-3L

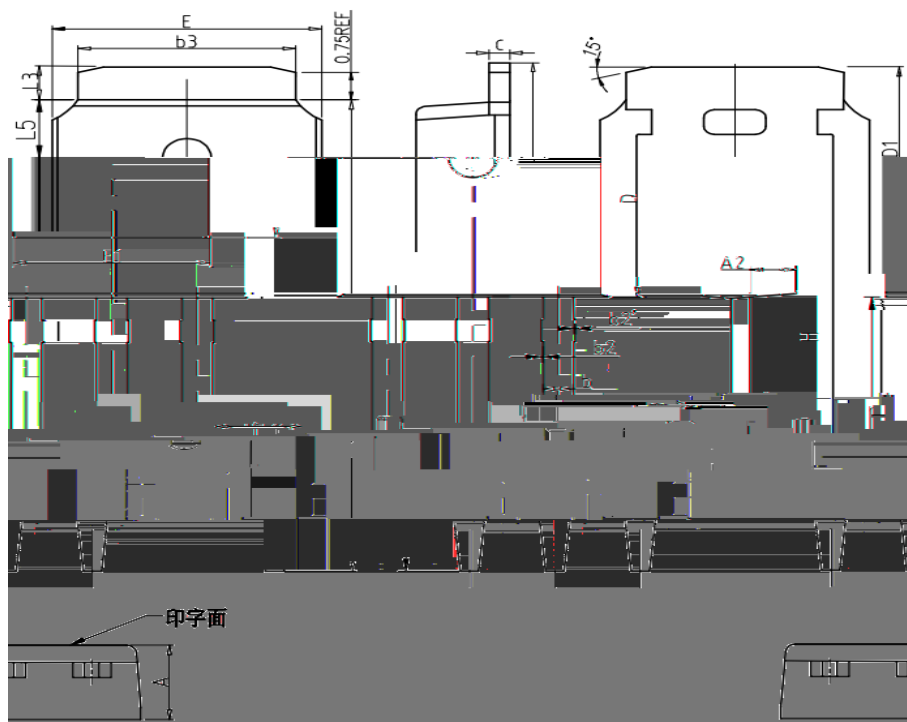

COMMON DIMENSIONS			
SYMBOL	mm		
	MIN	NOM	MAX
A	2.20	2.30	2.40
A2	0.97	1.07	1.17
b	0.68	0.78	0.90
b2	0.00	0.04	0.10
b2'	0.00	0.04	0.10
b3	5.20	5.33	5.50
c	0.43	0.53	0.63
D	5.98	6.10	6.22
D1	5.30REF		
E	6.40	6.60	6.80
E1	4.63	-	-
e	2.286BSC		
H	16.22	16.52	16.82
L1	9.15	9.40	9.65
L3	0.88	1.02	1.28
L5	1.65	1.80	1.95

TO-251-3S

COMMON DIMENSIONS			
SYMBOL	mm		
	MIN	NOM	MAX

Classification Profile

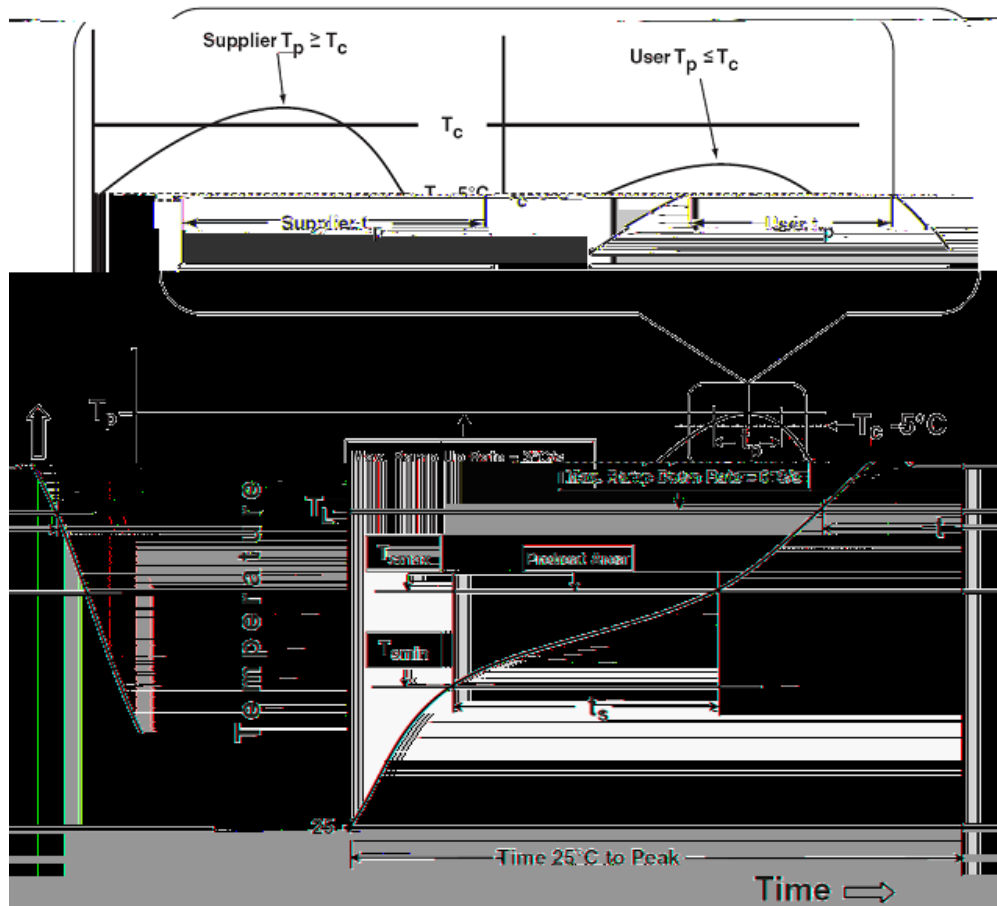

Classification Reflow Profiles

Profile Feature	Sn-Pb Eutectic Assembly	Pb-Free Assembly
Preheat & Soak		
Temperature min (T_{smin})	100 °C	150 °C
Temperature max (T_{smax})	150 °C	200 °C
Time (T_{smin} to T_{smax}) (t_s)	60-120 seconds	60-120 seconds
Average ramp-up rate (T_{smax} to T_p)	3 °C/second max.	3°C/second max.
Liquidous temperature (T_L)	183 °C	217 °C
Time at liquidous (t_L)	60-150 seconds	60-150 seconds
Peak package body Temperature (T_p)*	See Classification Temp in table 1	See Classification Temp in table 2
Time (t_p)** within 5°C of the specified classification temperature (T_c)	20** seconds	30** seconds
Average ramp-down rate (T_p to T_{smax})	6 °C/second max.	6 °C/second max.
Time 25°C to peak temperature	6 minutes max.	8 minutes max.

*Tolerance for peak profile Temperature (T_p) is defined as a supplier minimum and a user maximum.

** Tolerance for time at peak profile temperature (t_p) is defined as a supplier minimum and a user maximum.

Table 1.SnPb Eutectic Process Classification Temperatures (Tc)

Package Thickness	Volume mm <350	Volume mm 350
2.5 mm	235 °C	220 °C
	220 °C	220 °C

Table 2.Pb-free Process Classification Temperatures (Tc)

Package Thickness	Volume mm <350	Volume mm 350-2000	Volume mm 2000
<1.6 mm	260 °C	260 °C	260 °C
1.6 mm 2.5 mm	260 °C	250 °C	245 °C
2.5 mm	250 °C	245 °C	245 °C

Reliability Test Program

Test item	Method	Description
MSL	JESD22-A113	85°C/85%/168Hrs
RSH	JESD22- B106(PTH)	260 5 10 1S
PCT	JESD22-A102	121 ,100%RH, 96hours, 205KPa
TCT	JESD22-A104	1000 Cycles, -55°C~150°C
HTRB	JESD22-A108B	1000 Hrs, 100% BV _{DSS} @ 175
HTGB	JESD22-A108B	1000 Hrs, 100%V _{gs} @ 175
BHAST	JESD22-A110D	130 85%RH 230KPA;U=32V
IOL	MIL-STD-750	Ta=25 , Tj 100 , Ton/Toff 3.5min 8600cycles

Customer Service

Worldwide Sales and Service: sales@hymexa.com

Technical Support:Technology@hymexa.com

Huayi Microelectronics Co., Ltd.

No.8928,Shangji Road,Economic and Technological Development Zone,Xi'an,China

TEL: (86-029) 86685706

FAX: (86-029) 86685705

E-mail: sales@hymexa.com

Web net: <http://www.hymexa.com/>