

## N-Channel Enhancement Mode MOSFET

### Feature

- 100V/180A  
 $R_{DS(ON)}=3.2m$  (typ.) @  $V_{GS} = 10V$
- 100% Avalanche Tested
- Reliable and Rugged
- Lead-Free and Green Devices Available (RoHS Compliant)

### Pin Description

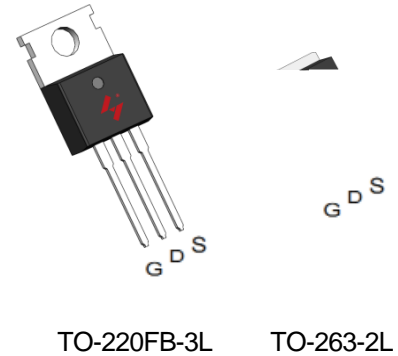

### Applications

- Power Switching application
- DC-DC Converters
- Motor control

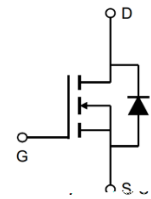

N-Channel MOSFET

### Ordering and Marking Information

<div style="background-color: black; width: 20px; height: 15px; margin: 0 auto;"></div> <b>P</b> <b>G035N10</b> XYMXXXXXX	<div style="background-color: black; width: 20px; height: 15px; margin: 0 auto;"></div> <b>B</b> <b>G035N10</b> XYMXXXXXX	Package Code P :TO-220FB-3L      B:TO-263-2L  Date Code XYMXXXXXX
---	---	---

Note: HUAYI lead-free products contain molding compounds/die attach materials and 100% matte tin plate Termination finish; which are fully compliant with RoHS. HUAYI lead-free products meet or exceed the lead-Free requirements of IPC/JEDEC J-STD-020 for MSL classification at lead-free peak reflow temperature. HUAYI defines Green to mean lead-free (RoHS compliant) and halogen free (Br or Cl does not exceed 900ppm by weight in homogeneous material and total of Br and Cl does not exceed 1500ppm by weight).

HUAYI reserves the right to make changes, corrections, enhancements, modifications, and improvements to this product and/or to this document at any time without notice.

## Absolute Maximum Ratings

Symbol	Parameter		Rating	Unit
<b>Common Ratings</b> (Tc=25°C Unless Otherwise Noted)				
V <sub>DSS</sub>	Drain-Source Voltage		100	V
V <sub>GSS</sub>	Gate-Source Voltage		±20	V
T <sub>J</sub>	Junction Temperature Range		-55 to 175	°C
T <sub>STG</sub>	Storage Temperature Range		-55 to 175	°C
I <sub>S</sub>	Source Current-Continuous(Body Diode)	Tc=25°C	180	A
<b>Mounted on Large Heat Sink</b>				
I <sub>DM</sub>	Pulsed Drain Current *	Tc=25°C	490	A
I <sub>D</sub>	Continuous Drain Current	Tc=25°C	180	A
		Tc=100°C	127	A
P <sub>D</sub>	Maximum Power Dissipation	Tc=25°C	220	W
		Tc=100°C	110	W
R <sub>θJC</sub>	Thermal Resistance, Junction-to-Case		0.68	°C/W
R <sub>θJA</sub>	Thermal Resistance, Junction-to-Ambient **		62.5	°C/W
E <sub>AS</sub>	Single Pulsed-Avalanche Energy ***	L=0.3mH	720	mJ

Note: \* Repetitive rating pulse width limited by max. junction temperature.  
 \*\* Surface mounted on FR-4 board.  
 \*\*\* Limited by T<sub>Jmax</sub>, starting T<sub>J</sub>=25°C, L = 0.3mH, V<sub>DS</sub>=80V, V<sub>GS</sub> =10V.

## Electrical Characteristics(Tc =25°C Unless Otherwise Noted)

Symbol	Parameter	Test Conditions	HYG035N10NS2			Unit
			Min	Typ.	Max	
<b>Static Characteristics</b>						
BV <sub>DSS</sub>	Drain-Source Breakdown Voltage	V <sub>GS</sub> =0V, I <sub>DS</sub> =250 A	100	-	-	V
I <sub>DSS</sub>	Drain-to-Source Leakage Current	V <sub>DS</sub> =100V, V <sub>GS</sub> =0V	-	-	1.0	A
		T <sub>J</sub> =125°C	-	-	50	A
V <sub>GS(th)</sub>	Gate Threshold Voltage	V <sub>DS</sub> =V <sub>GS</sub> , I <sub>DS</sub> =250 A	2	3	4	V
I <sub>GSS</sub>	Gate-Source Leakage Current	V <sub>GS</sub> = 20V, V <sub>DS</sub> =0V	-	-	±100	nA
R <sub>DS(ON)*</sub>	Drain-Source On-State Resistance	V <sub>GS</sub> =10V, I <sub>DS</sub> =50A	-	3.2	4	mΩ
<b>Diode Characteristics</b>						
V <sub>SD*</sub>	Diode Forward Voltage	I <sub>SD</sub> =50A, V <sub>GS</sub> =0V	-	0.88	1.3	V
t <sub>rr</sub>	Reverse Recovery Time	I <sub>SD</sub> =50A, dI <sub>SD</sub> /dt=100A/	-	78	-	ns
Q <sub>rr</sub>	Reverse Recovery Charge		-	192	-	nC

## Electrical Characteristics (Cont.) (T<sub>c</sub> =25°C Unless Otherwise Noted)

Symbol	Parameter	Test Conditions	HYG035N10NS2			Unit
			Min	Typ.	Max	
<b>Dynamic Characteristics</b>						
R <sub>G</sub>	Gate Resistance	V <sub>GS</sub> =0V, V <sub>DS</sub> =0V, F=1MHz	-	2.1	-	Ω
C <sub>iss</sub>	Input Capacitance	V <sub>GS</sub>				

## Typical Operating Characteristics

Figure 1: Power Dissipation

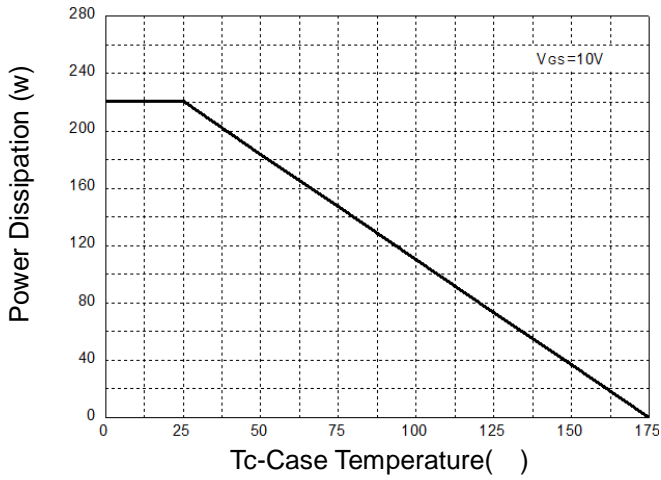

Figure 2: Drain Current

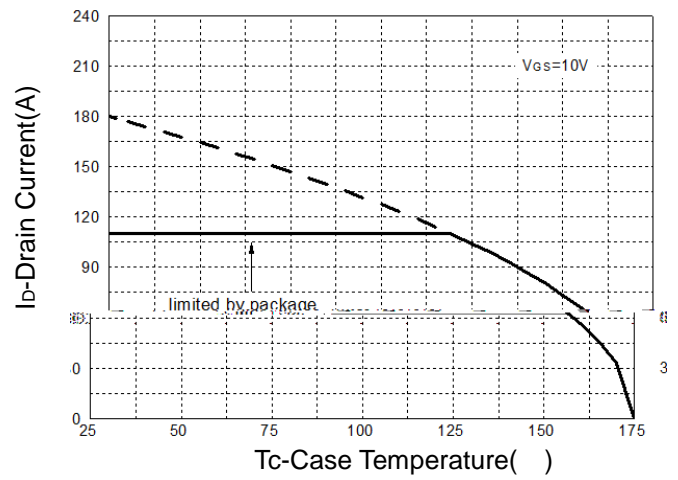

Figure 3: Safe Operation Area

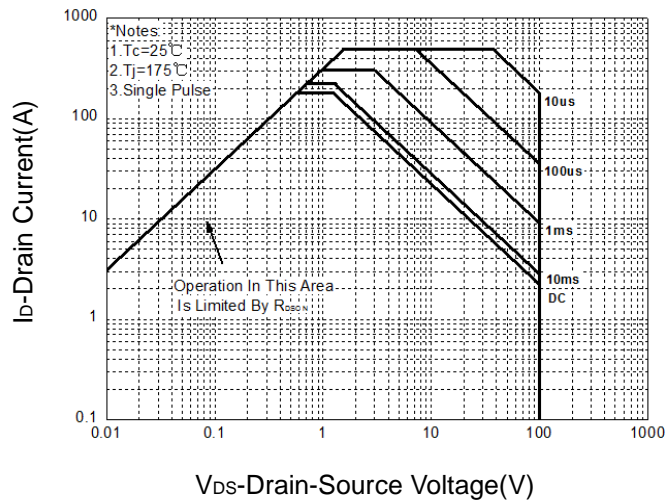
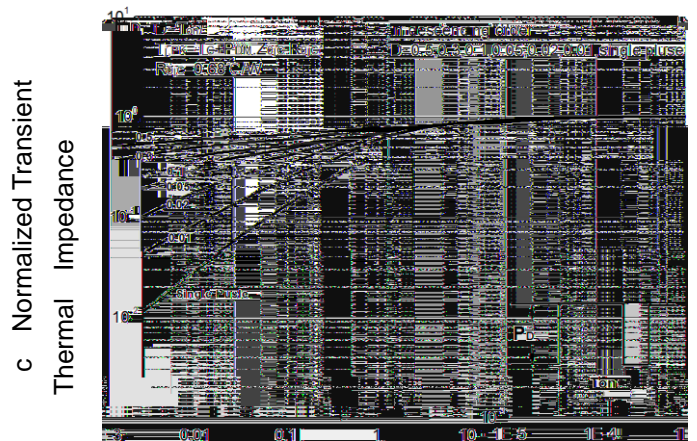

Figure 4: Thermal Transient Impedance



Maximum Effective Transient Thermal Impedance, Junction-to-Case

Figure 5: Output Characteristics

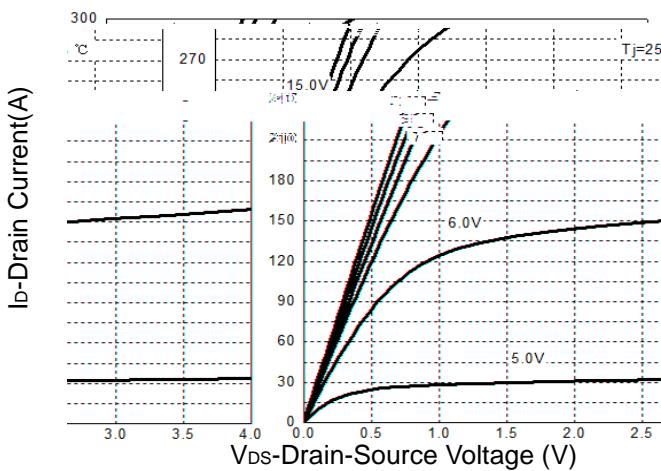
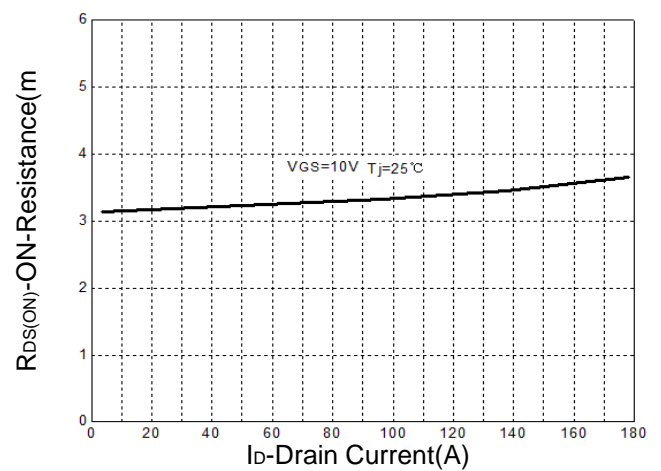

Figure 6: Drain-Source On Resistance



## Typical Operating Characteristics(Cont.)

Figure 7: On-Resistance vs. Temperature

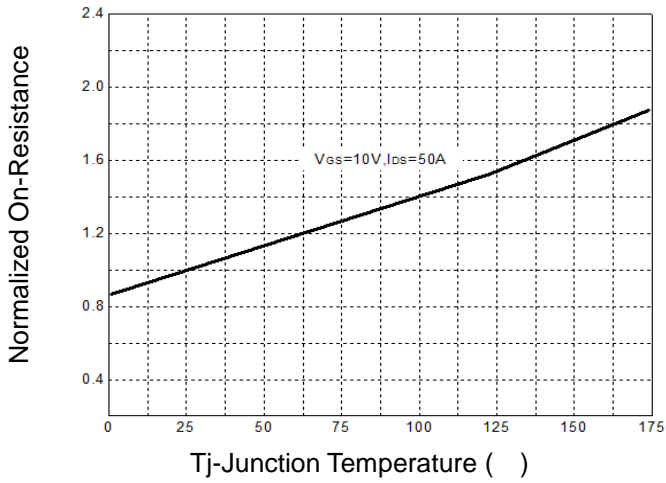

Figure 8: Source-Drain Diode Forward

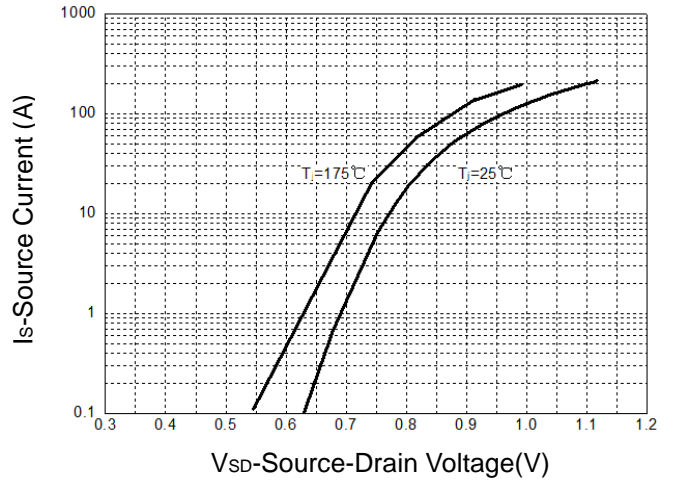

Figure 9: Capacitance Characteristics

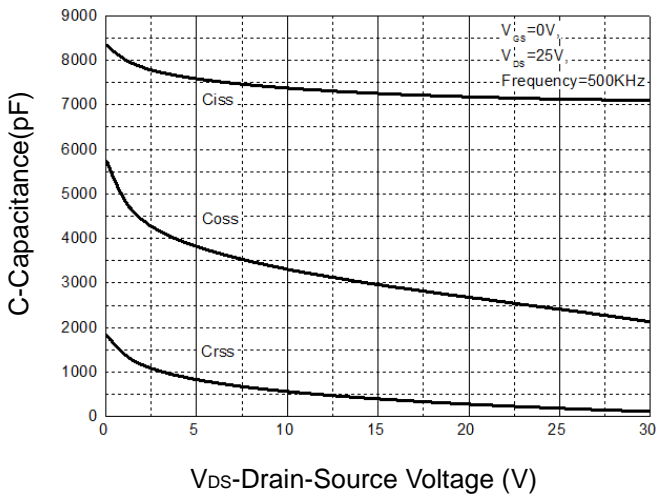
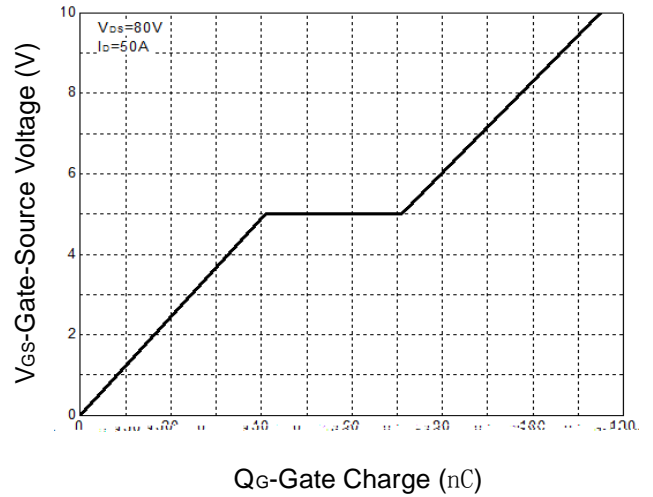
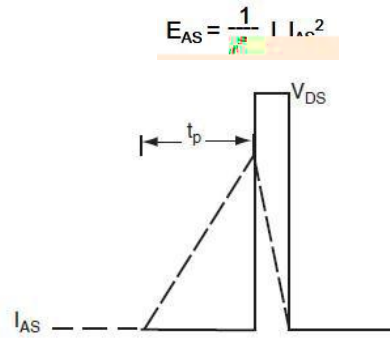
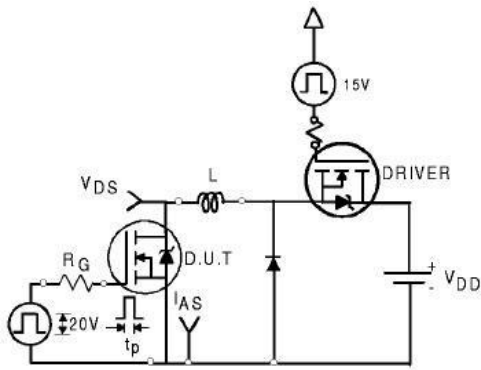

Figure 10: Gate Charge Characteristics



**Avalanche Test Circuit**



**Switching Time Test Circuit**

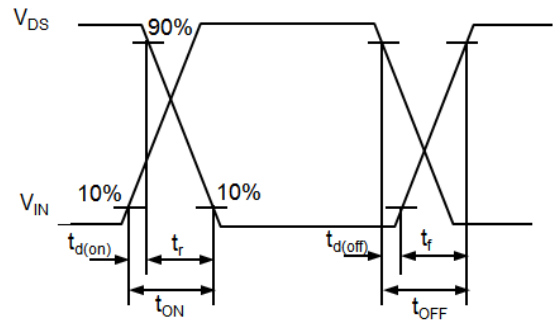
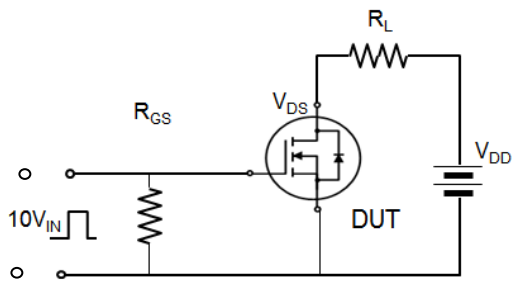

**Gate Charge Test Circuit**

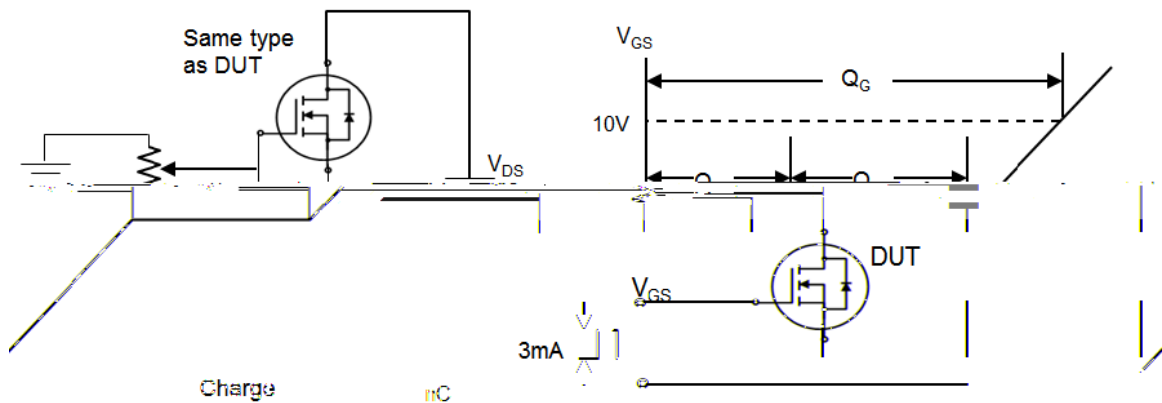

# HYG035N10NS2P/B

## Device Per Unit

Package Type	Unit	Quantity
TO-220FB-3L	Tube	50
TO-263-2L	Tube	50
TO-263-2L	Reel	800

## Package Information

### TO-263-2L

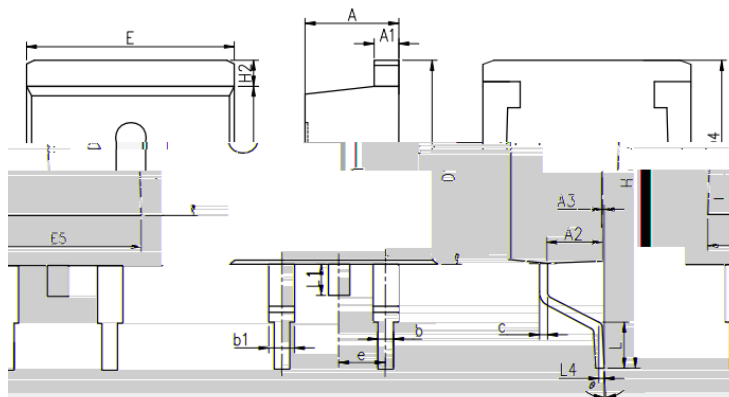

COMMON DIMENSIONS

SYMBOL	mm		
	MIN	NOM	MAX
A	4.37	4.57	4.77
A1	1.22	1.27	1.42
A2	2.49	2.69	2.89
A3	0	0.13	0.25
b	0.7	0.81	0.96
b1	1.17	1.27	1.47
c	0.3	0.38	0.53
D1	8.5	8.7	8.9
D4	6.6	-	-
E	9.86	10.16	10.36
E5	7.06	-	-
e	2.54 BSC		
H	14.7	15.1	15.5
H2	1.07	1.27	1.47
L	2	2.3	2.6
L1	1.4	1.55	1.7
L4	0.25 BSC		
	0°	5°	9°



---

## **Classification Profile**

## **Classification Reflow Profiles**

**Profile Feature**

Table 1.SnPb Eutectic Process Classification Temperatures (Tc)

Package Thickness	Volume mm <350	Volume mm 350
2.5 mm	235 °C	220 °C
	220 °C	220 °C

Table 2.Pb-free Process Classification Temperatures (Tc)

Package Thickness	Volume mm <350	Volume mm 350-2000	Volume mm 2000
<1.6 mm	260 °C	260 °C	260 °C
1.6 mm 2.5 mm	260 °C	250 °C	245 °C
2.5 mm	250 °C	245 °C	245 °C

## Reliability Test Program

Test item	Method	Description
SOLDERABILITY	JESD-22, B102	5 Sec, 245°C
HTRB	JESD-22, A108	168/500/1000 Hrs, Bias @ 150°C
HTGB	JESD-22, A108	168 /500/1000Hrs, Vgs200% @ 150°C
PCT	JESD-22, A102	96 Hrs, 100%RH, 2atm, 121°C
TCT	JESD-22, A104	500 Cycles, -55°C~150°C

### Customer Service

Worldwide Sales and Service: sales@hymexa.com

Technical Support: Technology@hymexa.com

Huayi Microelectronics Co., Ltd.

No.8928,Shangji Road,Economic and Technological Development Zone,Xi'an,China

TEL: (86-029) 86685706

FAX: (86-029) 86685705

E-mail: sales@hymexa.com

Web net: www.hymexa.com