

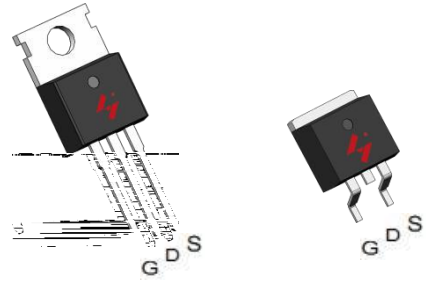

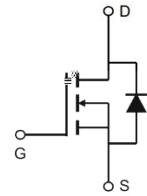

- 
- 
- 
- 



- 
- 



		
---	---	--

0			
0			



5D/H

---

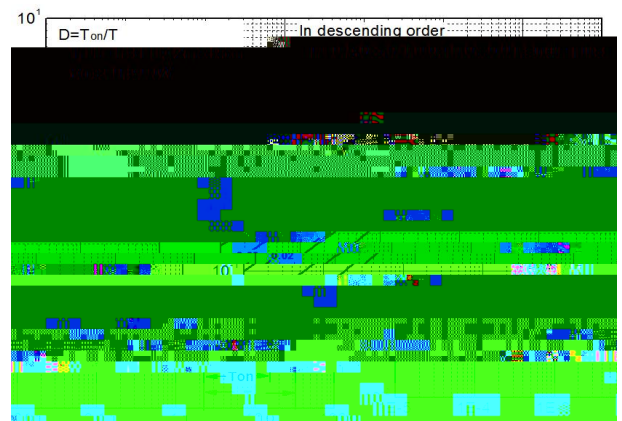
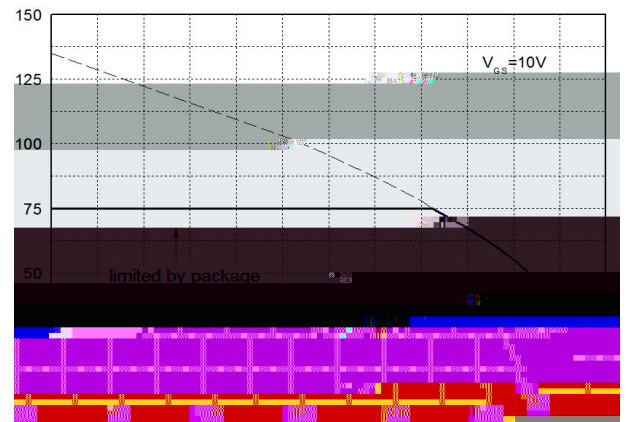
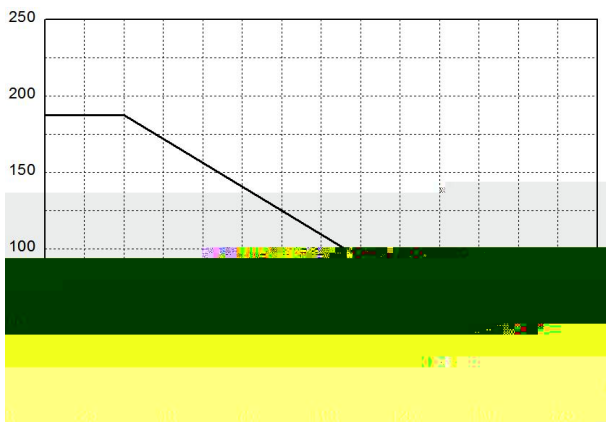
---

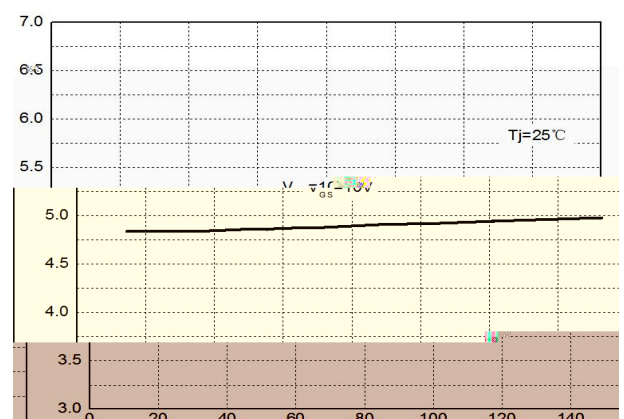
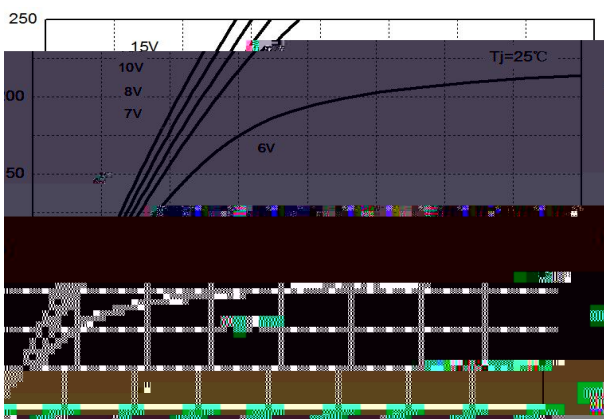

Maximum Effective Junction Temperature  
Thermal Impedance Junction to Case



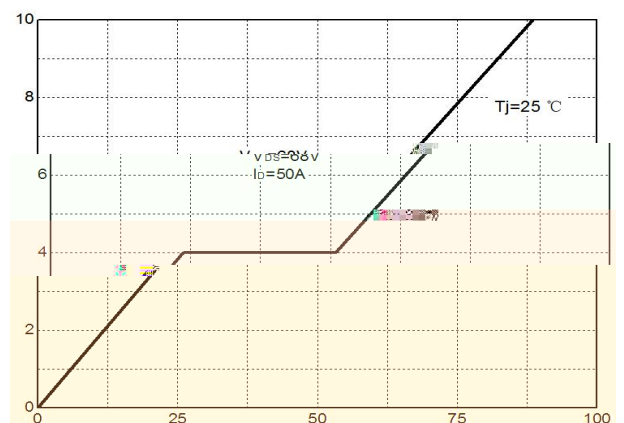
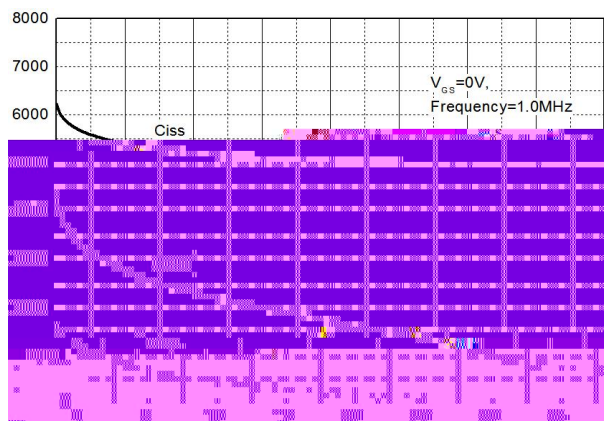
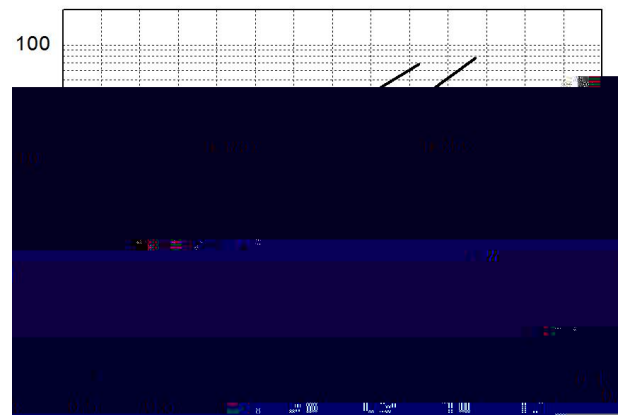
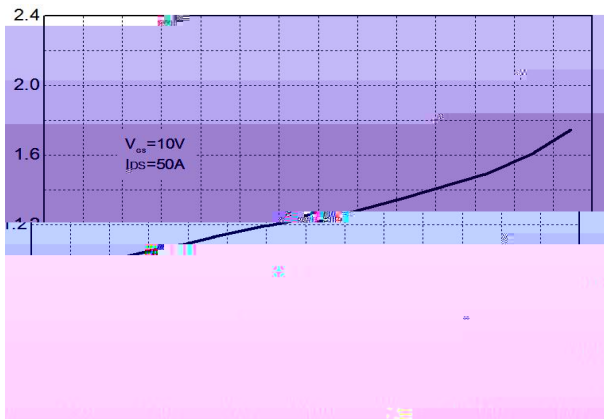

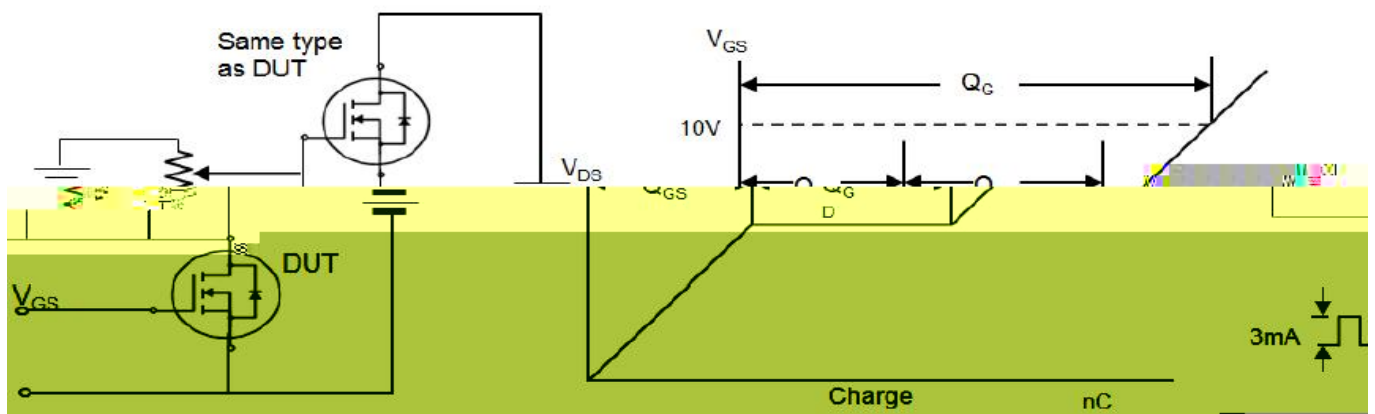
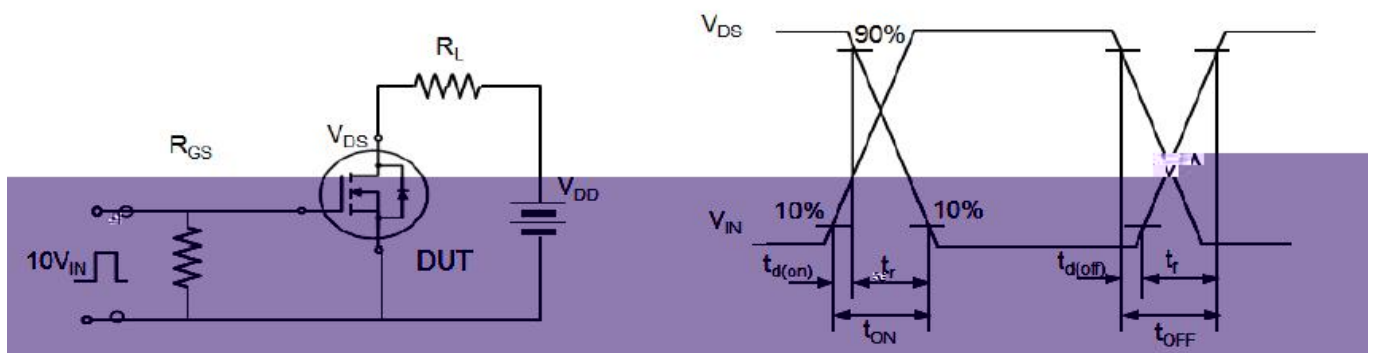
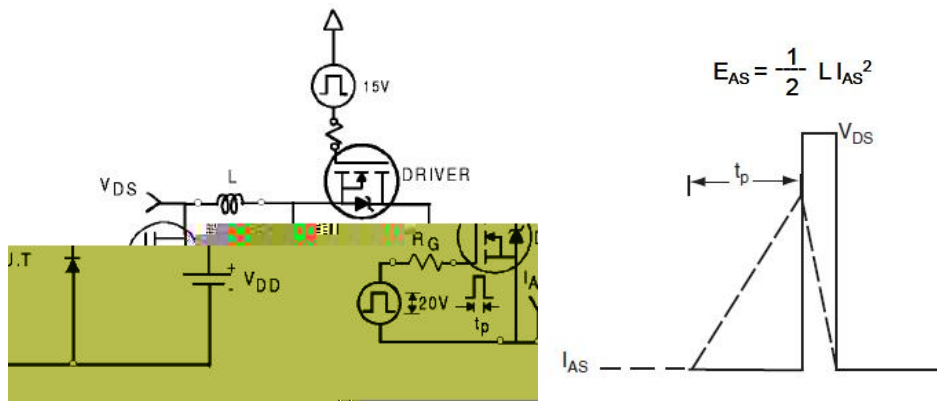









---



---